





27 632 811



- 167mm projection
- spout: rectangular normal flow
- max. flow 23.8 l/min at 3 bar flow pressure
- Hand shower: COMPACT RAIN, max. flow rate 6.8 l/min (at 3 bar)
- complete hand shower set with anti-scale system
- automatic bath/shower diverter
- height of mixer 198 mm
- height up to aerator 133 mm
- hole diameter spout 28 mm
- hole diameter for complete hand shower set 32 mm
- rosette for mixer 60 x 60mm
- rosette for complete hand shower set 60 x 60mm
- metal shower hose 1750mm with integrated anti-twist protection

Intrinsic protection against back flow.

	Chrome	27 632 811-00
	Brushed Platinum	27 632 811-06
	Dark Chrome	27 632 811-19
	Brushed Durabronze (23kt Gold)	27 632 811-28
	Brushed Dark Platinum	27 632 811-99

**Recommended miscellaneous**



**Perfecto installation kit - 12 614 970 90**

27 632 811

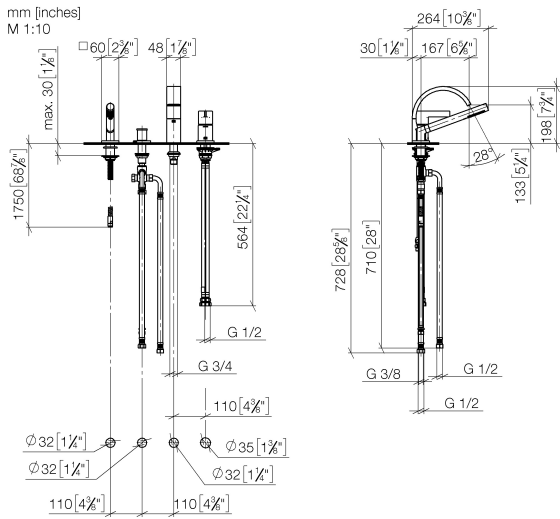

Flow rate chart

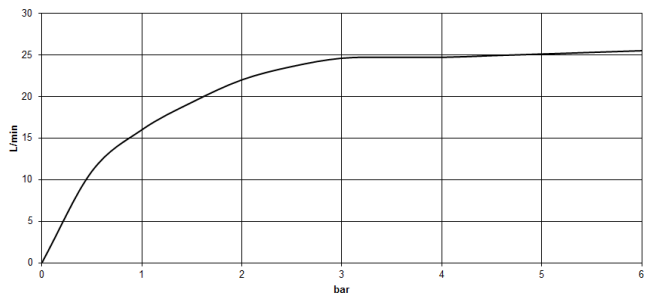

Certificates

LGA\_38124.

IAPMO\_4976 (6).

WRAS\_2204006.

Belgaqua\_21-380-27\_4.

27 632 811





## CYO Bath shower set for bath rim or tile edge installation - Chrome

CYO

27 632 811

### Spare parts list

No.	Item Number	Name	Quantity used	Delivery time
1	27 702 980-00	Hand shower set for bath rim or tile edge installation - Chrome	1	10
2	29 140 670-00	Two-way diverter for bath rim or tile edge installation - Chrome	1	10
3	90 11 70 013 00-00	spout	1	10
4	90 19 70 011 00-00	connection	1	10
5	09 14 10 009 90	seal	1	2
6	09 30 01 117 90	connection	1	2
7	09 23 01 057 90	flow reducer	1	2
8	04 23 10 044 09 90	fixing set	1	2
9	90 31 20 087 00-00	plug	1	10
10	90 31 11 063 00 90	pin	1	2
11	09 20 67 007-00	handle	1	10
12	09 28 30 037-00	cover	1	10
13	09 31 11 044 90	pin	1	2
14	09 27 67 016-00	rosette	1	10
15	09 24 04 448 90	nut	1	2
16	90 15 05 039 00 90	cartridge	1	2
17	09 14 10 201 90	seal	2	2
18	09 30 11 060 90	disc	1	2
19	04 23 10 044 02 90	fixing set	1	2
20	04 23 30 041 00 90	threaded connector	1	2
21	04 30 04 021 00 90	hose	2	2
22	09 24 03 185-00	nipple	2	10
23	09 14 05 004 90	seal	2	2